

CF1: Picnic Table
Instruction Manual

Raw Material:

- 1x 14ft 2x10 Lumber
- 4x A-Frame

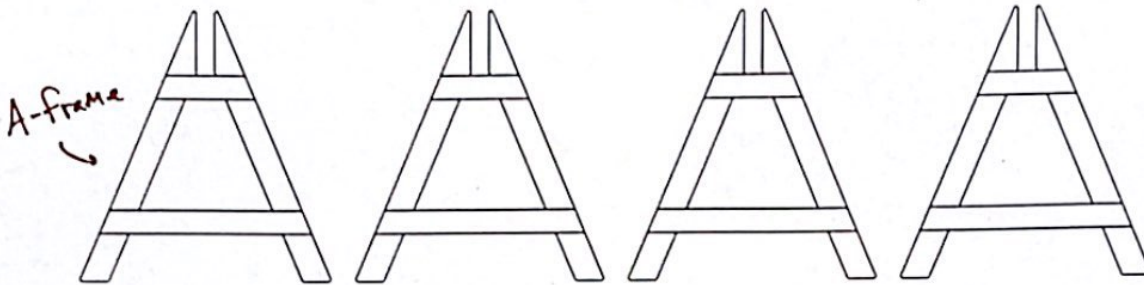
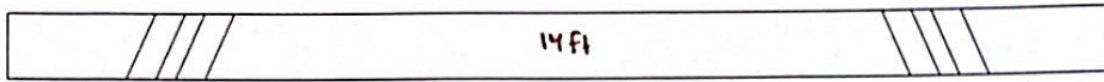

Preparation:

- Divide barrier into 4 roughly equal parts
- Cut top of two A-frames as table-top supports
- Use vertical pieces of third A-frame as seat supports
- Create two notched cross-braces out of last A-frame

do this last so you can eyeball the proper cut locations

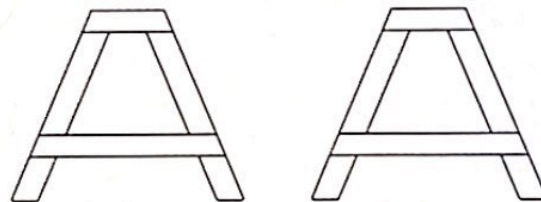
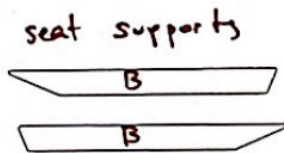
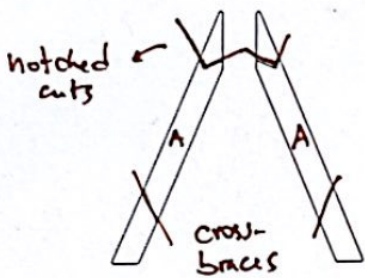
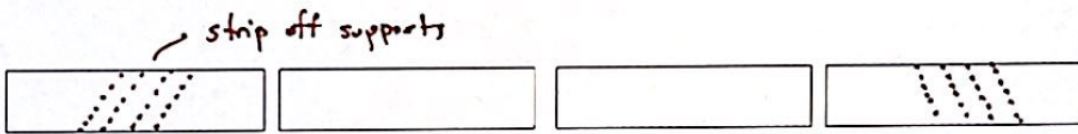

Assembly:

- 30 screws
(it's symmetric)

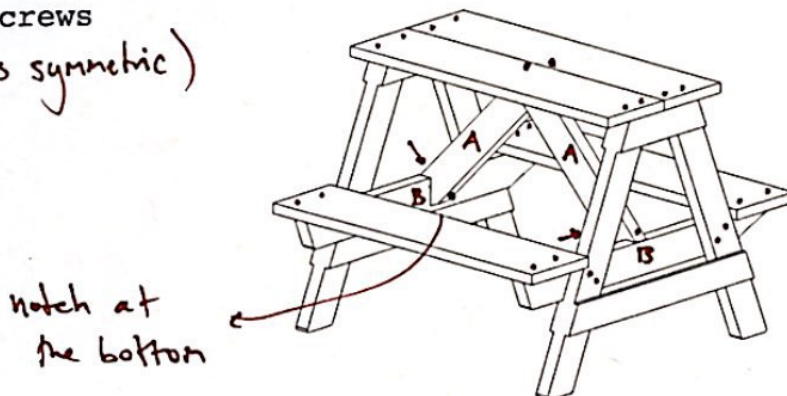

CF2: Park Bench
Instruction Manual

Raw Material:

- 1x 14ft 2x10 Lumber
- 2x A-Frame

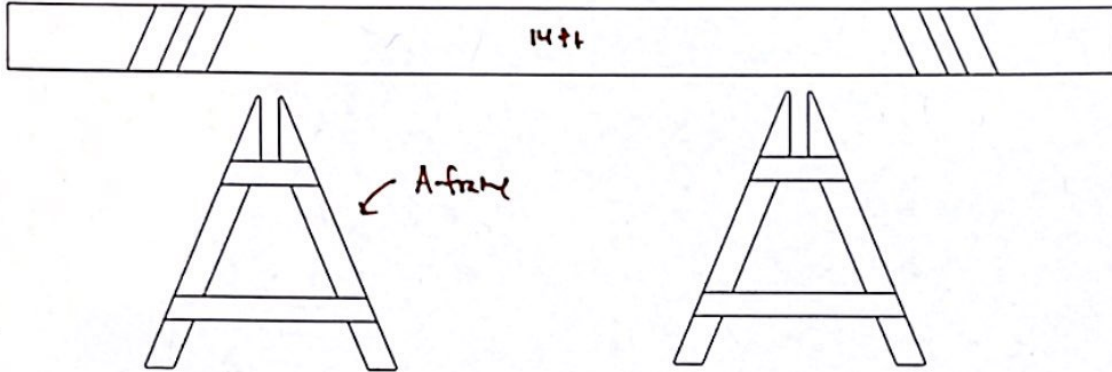

Preparation:

- Divide barrier into 3 roughly equal parts
- 2 cuts per A-Frame
- Re-arrange parts into bench legs

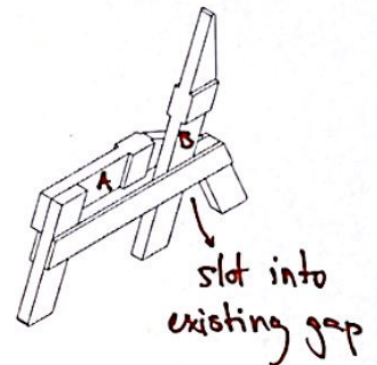
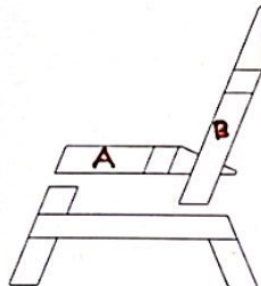
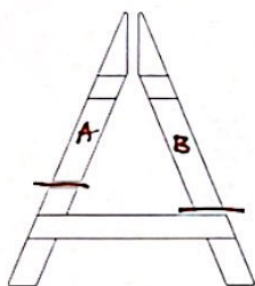
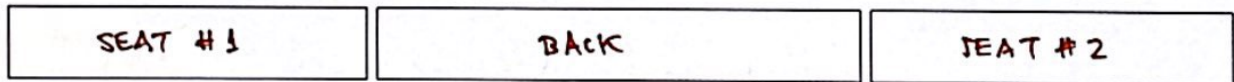

Assembly:

- 12 screws

